

NAME	ORBITAL LEAF IP65 "FLOW CONTROL"																																																																				
REFERENCE	650746	TEXT. BLACK	3400K																																																																		
	650747	TEXT. WHITE	3400K																																																																		
	650766	TEXT. BLACK	4000K*																																																																		
	650767	TEXT. WHITE	4000K*																																																																		
	650786	TEXT. BLACK	HALOSPHERE**																																																																		
	650787	TEXT. WHITE	HALOSPHERE**																																																																		
SPECIFICATIONS	<table border="1"> <tr> <td>Safe distance to object</td> <td colspan="2">☹ - 0,1m - ☹</td> </tr> <tr> <td>Lamp type</td> <td colspan="2">Annular LED array</td> </tr> <tr> <td>CCT</td> <td colspan="2">2700K/3000K*/3000K>1800K**</td> </tr> <tr> <td>Luminous flux</td> <td colspan="2">1460lm/1486lm*/1230lm**</td> </tr> <tr> <td>Power</td> <td colspan="2">12,3W/12,7W**</td> </tr> <tr> <td>Current</td> <td colspan="2">350mA</td> </tr> <tr> <td>Forward voltage</td> <td colspan="2">35,1V/36V**</td> </tr> <tr> <td>Symbol</td> <td colspan="2"></td> </tr> <tr> <td>Gear</td> <td colspan="2">Converter not incorporated</td> </tr> <tr> <td>IP / Class</td> <td colspan="2">IP65</td> </tr> <tr> <td>Orientability</td> <td colspan="2">None</td> </tr> <tr> <td>Dimmability</td> <td colspan="2">CCR, PWM dimmable/CCR dimmable**</td> </tr> <tr> <td>Beam angle</td> <td colspan="2">120°</td> </tr> <tr> <td>CRI</td> <td colspan="2">92/87**</td> </tr> <tr> <td>SDCM</td> <td colspan="2">3</td> </tr> <tr> <td>Ventilation valve</td> <td colspan="2">Supply air/extract air</td> </tr> <tr> <td>Adjustable flow regulator</td> <td colspan="2">Incorporated</td> </tr> <tr> <td>Application</td> <td colspan="2">Interior - Ceiling Mounted</td> </tr> <tr> <td>Installation</td> <td colspan="2">Leaf springs</td> </tr> <tr> <td>Material</td> <td colspan="2">Powdercoated aluminium</td> </tr> <tr> <td>Weight</td> <td colspan="2"> 0,5</td> </tr> <tr> <td>Installation depth / cut out</td> <td>180mm</td> <td>Ø125mm</td> </tr> </table>			Safe distance to object	☹ - 0,1m - ☹		Lamp type	Annular LED array		CCT	2700K/3000K*/3000K>1800K**		Luminous flux	1460lm/1486lm*/1230lm**		Power	12,3W/12,7W**		Current	350mA		Forward voltage	35,1V/36V**		Symbol			Gear	Converter not incorporated		IP / Class	IP65		Orientability	None		Dimmability	CCR, PWM dimmable/CCR dimmable**		Beam angle	120°		CRI	92/87**		SDCM	3		Ventilation valve	Supply air/extract air		Adjustable flow regulator	Incorporated		Application	Interior - Ceiling Mounted		Installation	Leaf springs		Material	Powdercoated aluminium		Weight	0,5		Installation depth / cut out	180mm	Ø125mm
Safe distance to object	☹ - 0,1m - ☹																																																																				
Lamp type	Annular LED array																																																																				
CCT	2700K/3000K*/3000K>1800K**																																																																				
Luminous flux	1460lm/1486lm*/1230lm**																																																																				
Power	12,3W/12,7W**																																																																				
Current	350mA																																																																				
Forward voltage	35,1V/36V**																																																																				
Symbol																																																																					
Gear	Converter not incorporated																																																																				
IP / Class	IP65																																																																				
Orientability	None																																																																				
Dimmability	CCR, PWM dimmable/CCR dimmable**																																																																				
Beam angle	120°																																																																				
CRI	92/87**																																																																				
SDCM	3																																																																				
Ventilation valve	Supply air/extract air																																																																				
Adjustable flow regulator	Incorporated																																																																				
Application	Interior - Ceiling Mounted																																																																				
Installation	Leaf springs																																																																				
Material	Powdercoated aluminium																																																																				
Weight	0,5																																																																				
Installation depth / cut out	180mm	Ø125mm																																																																			

MAXIMUM FLOW RATE	SOUND POWER (dB(A))	FLOW RATE (m³/h)	
		SUPPLY	EXHAUST
	35,0	68,0	85,0
	30,0	56,0	71,0
	25,0	47,0	59,0

NL Installatie- en onderhoudsrichtlijnen m.b.t. de fabrieksgarantie.
 1. De plaatsing, de aansluiting en het uittesten van dit toestel dient steeds te gebeuren door een erkend elektro-installeateur.
 2. Dit toestel moet geïnstalleerd, verbonden en getest worden volgens de nationaal geldende reglementen op elektrische installaties.
 3. De technische bijsluiter dient te worden beschouwd als een onderdeel van de algemene verkoopsvoorwaarden van TAL nv.
 4. De elektro-installeateur is verantwoordelijk voor het gebruik van compatibele voorschakelapparatuur die voldoen aan de geldende IEC normen.
 5. Reinig het toestel enkel met een zachte en lichtvochtige doek zonder reinigingsmiddel.
 6. Schakel altijd eerst de elektriciteit uit alvorens het toestel te plaatsen en te installeren.

EN Installation and maintenance instructions regarding the manufacturer's warranty.
 1. Installation, connection and testing of this product must always be performed by a certified electrician.
 2. This product must be installed, connected and tested in accordance with the applicable national regulations for electrical installations.
 3. The technical manual must be regarded as part of the general sales conditions of TAL nv.
 4. The electrical installer is responsible for the use of compatible control gear that meets the applicable IEC standards.
 5. Only clean the device with a soft and slightly moist cloth without detergent.
 6. Always switch off the electricity supply before installing and connecting the product.

DE Installations- und Wartungsanweisungen bezüglich der Herstellergarantie.
 1. Installation, Anschluß und Prüfung dieses Geräts soll nur von einem anerkannten Elektriker ausgeführt werden.
 2. Dieses Gerät soll in Übereinstimmung mit den nationalen geltenden Vorschriften für Elektroinstallationen installiert, angeschlossen und geprüft werden.
 3. Die technische Anleitung muß als Teil der allgemeinen Verkaufsbedingungen von TAL nv betrachtet werden.
 4. Der Elektroinstallateur ist verantwortlich für die Verwendung von kompatiblen Betriebsgeräten, die den geltenden IEC-Normen entsprechen.
 5. Reinigen Sie das Gerät nur mit einem weichen und leicht feuchten Tuch ohne Reinigungsmittel.
 6. Schalten Sie den Strom immer aus, bevor Sie das Gerät installieren und anschließen.

FR Instructions d'installation et d'entretien concernant la garantie du fabricant.
 1. L'installation, la connexion et les essais de cet appareil doivent toujours être effectués par un électricien reconnu.
 2. Cet appareil doit être installé, raccordé et testé conformément aux réglementations nationales pour les installations électriques.
 3. La notice technique doit être considérée comme faisant partie des conditions générales de vente de TAL SA.
 4. L'installateur électrique est responsable de l'utilisation d'un équipement de contrôle compatible qui satisfait aux normes CEI applicables.
 5. Nettoyez l'appareil uniquement avec un chiffon doux et légèrement humide sans détergent.
 6. Éteignez toujours l'électricité avant d'installer et de connecter l'appareil.

INSTALLATION

① Make hole Ø125mm (127mm)
(min. depth hollow ceilings: 180mm)

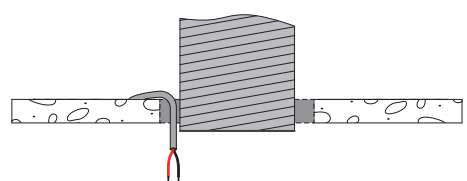
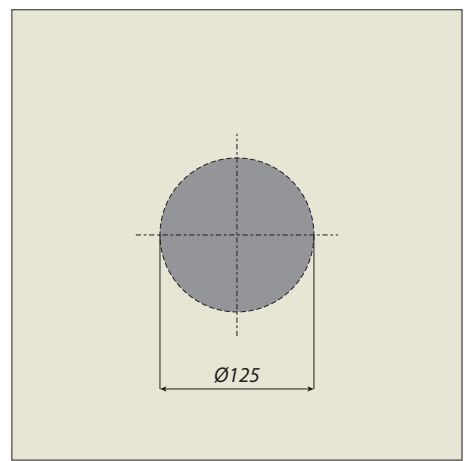
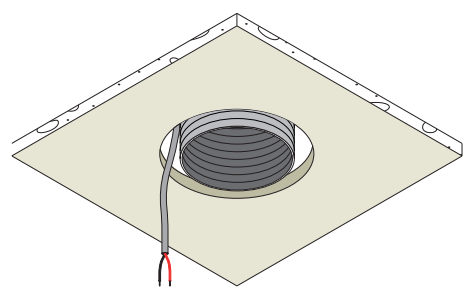

④ Regulate the air flow by rotating the adjuster & fixate with nut/washer

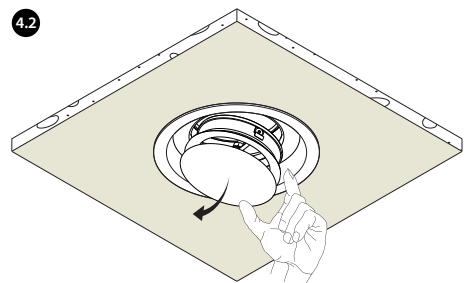
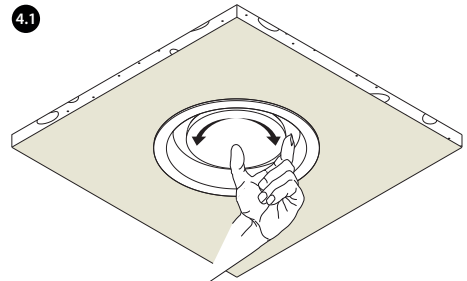

② Connect ventilation tube to the valve with hose clamp (a) & make electrical connection (b)

⚠ ALWAYS DISCONNECT MAINS POWER SUPPLY FROM CONVERTER BEFORE SWITCHING "ON" LED LUMINAIRES TO PREVENT HOT PLUGGING ISSUES!

③ Deform the leaf springs by hand and push the luminaire gently into the hole

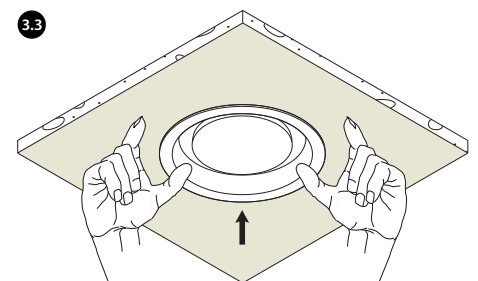
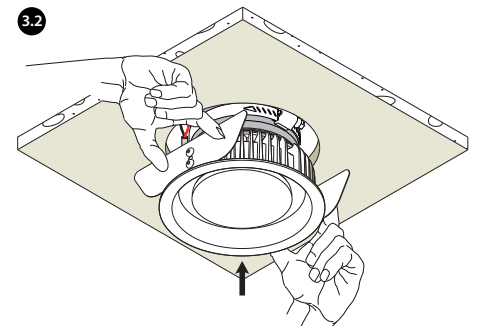
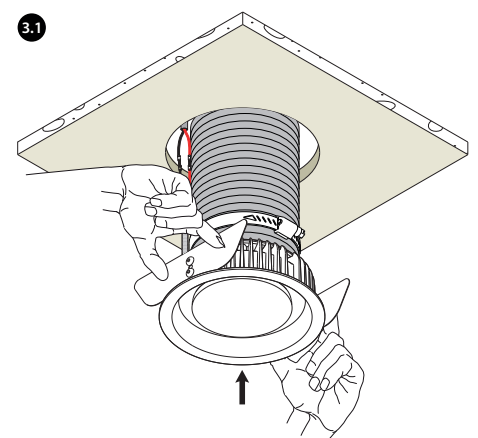

⑤ Switch on mains power supply

